

RENEWABLE



ENERGY

Pool Heating Systems

Residential Solar

A Buyer's Guide

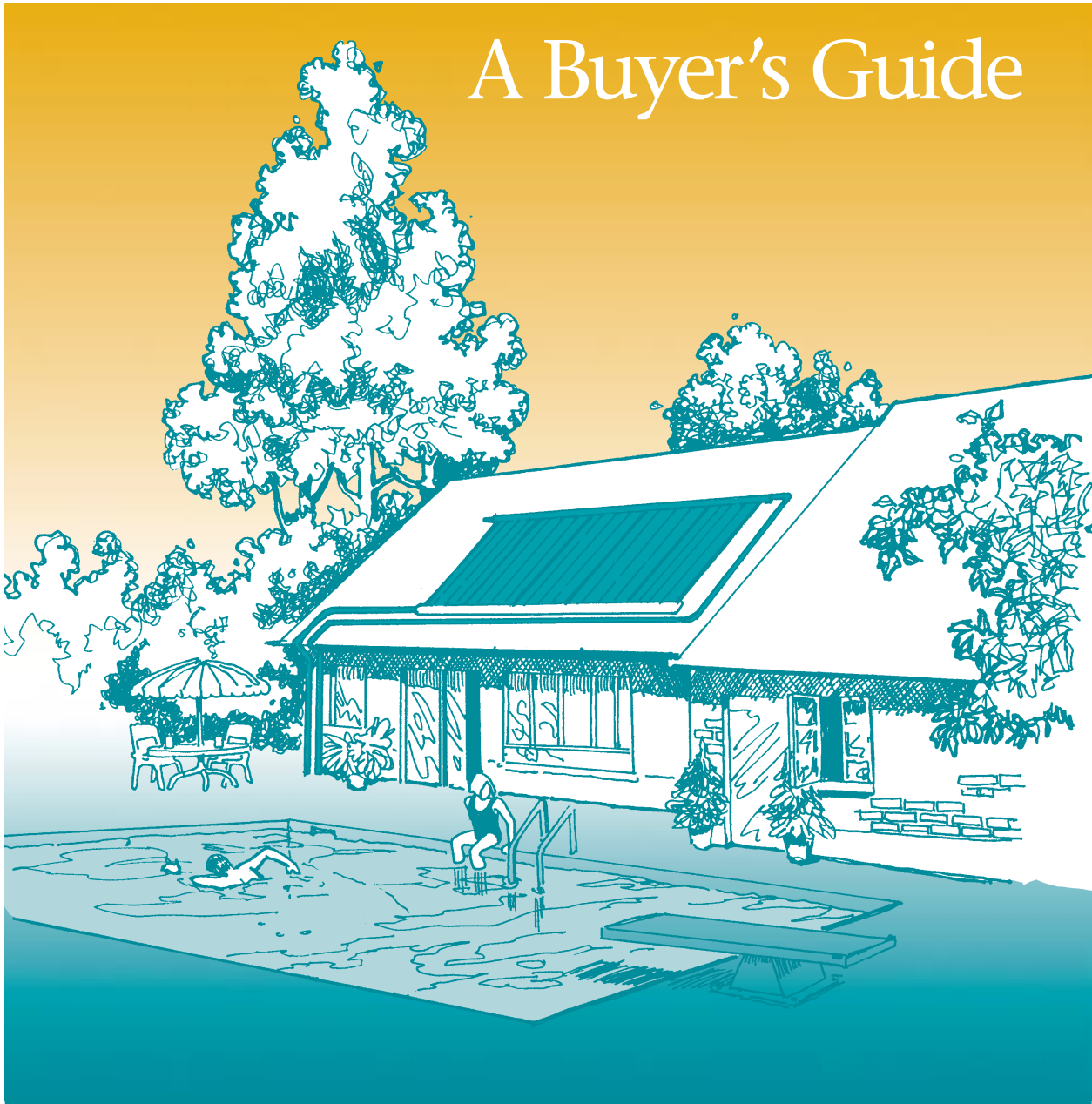

Natural Resources
Canada

Ressources naturelles
Canada

Canada

About this Guide

This Guide has been prepared to assist consumers with the purchase of a solar pool heater for their home pool. The Guide is not a “how to” manual on installing such a heater.

Natural Resources Canada believes that the numbers cited in this document – temperatures and costs, for example – to be accurate at time of publication. However, these numbers are provided for illustrative purposes only. Readers should expect some variation between the numbers cited in this document and those they find during their own research.

Residential Solar Pool Heating Systems: A Buyer's Guide

Prepared for Natural Resources Canada with the assistance of Taylor Munro Energy Systems Inc., Delta, British Columbia

This Guide builds upon the publication produced by the Ontario Ministry of Energy in 1982 entitled *Solar Heating for Swimming Pools*, which is no longer available for distribution. This new Guide is distributed for informational purposes only and does not necessarily reflect the views of the Government of Canada or constitute an endorsement of any commercial product or person. Neither Canada nor its ministers, officers, employees or agents makes any warranty in respect of this Guide or assumes any liability arising out of this Guide.

Aussi disponible en français sous le titre : *Chauffe-piscines solaires résidentiels : Guide de l'acheteur*

© Her Majesty the Queen in Right of Canada, 2001

Cat. No.: M92-223/2001E
ISBN 0-662-30665-1

Table of Contents

Introduction	2
Why Should I Consider Solar Pool Heating?	3
Five Good Reasons for Using Solar Heating	4
How Does a Solar Heater Work?	5
How Do Heat Pumps and Gas Heaters Compare to Solar?	6
How Do Costs for Heat Pumps and Gas Heaters Compare?	7
Summary – The Benefits of Solar	8
How Can I Best Manage My Pool’s Energy Use?	9
Pools Lose Heat	9
Pools Gain Heat	10
How Can I Reduce My Heating Load?	10
Summary	13
How Does Solar Work with Different Pool Types?	14
Outdoor Pools	14
Indoor Pools	15
Enclosed Pools	15
Hot Tubs and Spas	15
What Types of Solar Collectors are There?	16
Unglazed Solar Collectors – The Common Collector for Solar Pool Heating	16
Solar Collector Kit for Above-Ground Pools	18
Glazed Solar Collectors	18
What Size Solar Heater Do I Need?	19
Shading on the Pool	19
Location of Solar Collectors – Orientation and Tilt	20
Use of a Pool Cover	20
How Will My Solar Heater Be Installed and Maintained?	21
Most Collectors Can Be Mounted on Your Roof	21
Collectors Can Also be Mounted on Racks	22
You Can Choose a Manual or Automatic Control Valve	23
Activating the System is Straightforward	23
Maintenance is Easy	23
Special Care Must Be Taken with Winterization	23
How Do I Make the Best Decision as a Consumer?	24
Selecting a Solar Contractor	24
Selecting a Solar Collector	24
Understanding the Collector’s Warranty	24
Determining Your Potential Costs	25
Consumer Checklist	26
Appendix 1: Other Applications for Solar Water Heating	27
Related Publications	27
Further Information	27
Appendix 2: Glossary	28
Reader Survey	29

Introduction

There's nothing like a refreshing dip to beat summer's heat. Canada has about 600 000 backyard swimming pools. Many owners use pool heaters to heat their pools and in so doing end up spending millions of dollars a year on non-renewable fuels.

As the cost of gas, propane, oil and electricity continue to rise, the cost of heating swimming pools will become more and more expensive.

Fortunately, there is an economical alternative that will cut your energy costs while you enjoy your swim – solar heating.

Solar heating is simple, reliable and has been used by pool owners for years. The initial cost of solar equipment is reasonable, and the operational savings are high.

The payback period – the time it takes for your fuel savings to equal the cost of your solar heating system – can be as short as two to three swimming seasons. After that, your energy savings continue for the life of the system.

And, by replacing or reducing the use of conventional pool heaters, solar heaters help to eliminate greenhouse gases, such as carbon dioxide, that are having an impact on our climate.

Solar energy is a practical and economical way to heat your pool, extend your swimming season and increase your swimming comfort.



▲ *Tsawwassen, British Columbia.
This 5-m x 10-m (16-ft. x 32-ft.) in-ground pool has six 4.4-m² (4-ft. x 12-ft.) solar collectors.
Photo courtesy Taylor Munro Energy Systems.*

Why should I consider solar pool heating?



A solar heating system for your pool is an economical alternative to expensive conventional heaters. Solar collectors capture free energy from the sun and use it to heat your pool.

They extend your swimming season and reduce monthly fuel bills without depleting non-renewable fossil fuels.

In fact, solar pool heating for your home is the most economical solar application in Canada today. Solar heaters already make up more than 10 percent of all new pool heating-equipment sales.

▲ *Niagara Falls, Ontario.
This 5.5-m x 11-m (18-ft. x 36-ft.) in-ground pool
has five 4.4-m² (4-ft. x 12-ft.) solar collectors.
Photo courtesy of Daystar Energy.*

Five good reasons for using solar heating

From Victoria, British Columbia, to St. John's, Newfoundland, Canadians are using solar energy to heat their pools. Here are five good reasons why.

No. 1: Solar saves on pool heating costs

Energy costs continue to rise. In the last two years alone, the price of natural gas has more than doubled. On the other hand, the sun's energy is free, and more and more pool owners are taking advantage of this opportunity to save money and avoid future price increases.

Over a 15-year period, you could spend five times or more on heating with gas what you would spend on installing a solar heater today. Once your solar heating system is installed, there are no more heating bills to pay.

Many pool owners switch to solar because it meets all of their heating needs. But, even if you continue to use a gas or electric heater as a backup, solar heating is a smart investment that will save you money, year after year.

No. 2: Solar extends your swimming season

A properly sized solar heating system will get you swimming earlier in the spring and later into the fall. Whether or not you have an existing heater, you can keep your pool warmer and open longer with free energy from the sun. In most

areas of Canada, a solar heater used in combination with a solar pool cover can add two to four weeks to the beginning and two to four weeks to the end of the swimming season.

No. 3: Solar equipment is durable

Solar equipment often lasts longer than gas or electric heaters. With proper yearly maintenance, you can expect fuel heaters to last seven to 10 years. Most gas heaters come with a two-year warranty, and well-made heat pumps carry a two-year warranty with five years on the compressors.

Solar panels have a minimum 10-year warranty and generally last 15 to 20 years or longer.

No. 4: Solar requires less maintenance

Unlike gas and electric heaters, which should be serviced by a technician every year, a solar heater requires very little servicing. Again, that means less cost and less hassle for the pool owner.

No. 5: Solar energy is good for the environment

These days we hear a lot about the damaging effect that burning fossil fuels is having on the environment. Burning fuels releases nitrogen oxides that cause the formation of smog in urban areas. Urban smog, which is worse on warm and sunny days, affects people with respiratory problems such as asthma. Using solar energy instead of burning fossil fuels can help reduce this smog.

Burning fuels also produces carbon dioxide, the main cause of climate change. Replacing a natural gas or propane heater with a solar heater could stop three to 10 tonnes of carbon dioxide from entering the atmosphere each swimming season. That's about the same amount produced by operating your car for one year!

How does a solar heater work?

A solar pool heater is simple to operate and doesn't change the way you operate standard pool equipment. Figure 1 shows the components of a typical solar heater. Solar collectors are usually mounted on the roof of your home or other structure such as a shed or garage. This is the least expensive option and doesn't take up extra space on the property. When suitable roof space is not available, collectors can be ground-mounted on a rack.

The existing pool pump is used to circulate water from the pool through the solar collectors and back to the pool. On sunny days, an automatic controller diverts the water to the roof by a motorized valve. The automatic valve uses special temperature sensors to determine when the solar collectors should be used.

For those on a budget, a manual valve can be used. However, this tends to be an impractical option for most people because the valve must be turned at least twice a day at exactly the right time. Automatic and manual valves and controllers are discussed in the section on installing and maintaining a solar water heater on page 21.

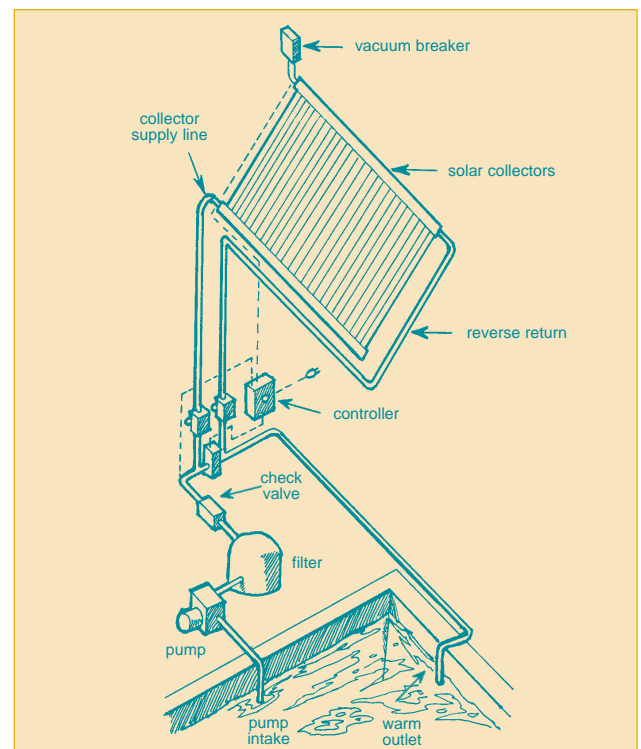

▲ Figure 1. Components of a solar pool heater.

How do heat pumps and gas heaters compare to solar?

Across Canada, some 60 percent of in-ground pools are heated. Although several different types of heaters are available, the most commonly used are natural gas heaters and electric air-source heat pumps. Natural gas heaters are popular in British Columbia and Ontario. In Quebec, where the availability of natural gas is less widespread, heat pumps are more popular. Roughly 10 percent of heated pools already use solar heaters.

Since a heat pump puts out considerably less power than a natural gas heater, it is important to correctly size the heat pump to ensure adequate heating for your pool. Its low output also means that it tends to run continuously, which can be excessively noisy for some pool owners. And, while it offers the advantage of being cheaper to operate than a gas heater, a heat pump may be less reliable and more prone to breaking.

A heat pump takes longer to raise the temperature of your pool than a natural gas heater, which can raise a cold pool to the desired temperature relatively quickly.

During sunny conditions, a solar pool heater can add heat as well as or better than many heat pumps. The temperature of a solar heated pool will fluctuate as weather conditions change. But, if a pool cover is used, the heat collected by solar panels on a sunny day can easily get you through a cool, cloudy period. And, water temperatures will be back up again after another day or two of sunshine.

Because of our climate, many Canadian consumers are sceptical that there is enough sunlight to support a solar pool heater. In fact, there is more than enough solar energy for pool owners across Canada to heat their pools without a backup heater from May through September.

Figure 2 shows what daytime temperatures a solar heater can provide for an in-ground pool in Ontario during the swimming season. A solar heater in Ontario will have no difficulty keeping a pool well above the desired temperature.

Solar pool heating can typically extend the length of your outdoor swimming season by two to four weeks at either end. With a solar system, it costs nothing in fuel to try for an early start or a late finish, whereas most people with a fuel heater can't afford to open their pool until good weather is guaranteed.

Because a sufficient area of solar panels must be used to obtain maximum performance at minimum cost, accurate sizing of the collector area is critical. See the section on determining collector size on page 19.

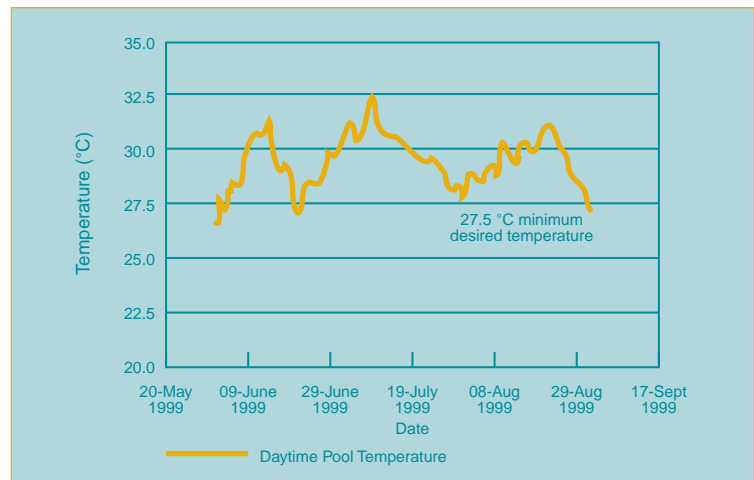

▲ Figure 2. Typical temperature profile for a solar heated pool in Ontario.

Type of Heater	Heater Cost	Additional Materials and Labour Cost	Total Cost
Natural Gas	\$1,700–\$2,900	\$600–\$2,000	\$2,300–\$4,900
Heat Pump	\$2,900–\$5,900	\$200–\$500	\$3,100–\$6,400
Solar	\$2,500–\$3,200	\$600–\$1,800	\$3,100–\$5,000

▲ Table 1. Estimated pool-heater installation costs for a 5-m x 10-m (16-ft. x 32-ft.) pool (figures for year 2000).

How do costs for heat pumps and gas heaters compare?

Installation costs

A solar heater is generally more expensive to install than a gas heater and less expensive than a heat pump.

Table 1 shows that in 2000 the typical cost of installing a solar pool heater for a 5-m by 10-m (16-ft. by 32-ft.) pool, on a suitably located roof, would be between \$3,100 and \$5,000.

A professionally installed system usually comes with a one-year warranty on the installation and a 10- to 12-year warranty on the collector. Ask your installer what the warranties come with your system.

Operating costs

Once a solar heater is installed and paid for, the energy to heat your pool is free. Solar heating systems are very easy for the homeowner to maintain – the only expense is your time. If you want to hire a solar technician to perform annual maintenance, it would cost approximately \$100 per year.

Using a natural gas heater, a typical 5-m by 10-m (16-ft. by 32-ft.) outdoor pool would cost between \$300 and \$600 to heat from May to September, if you use a solar cover (see Table 2).

If no cover is used, the typical cost is between \$600 and \$1,100. These costs are based on a natural gas price of \$9.13 per gigajoule, (GJ), so the fuel cost for your pool will depend on your current cost of natural gas. In addition, a recommended annual cleaning of a gas heater costs \$50 to \$100.

Depending on the price of electricity, a typical heat pump (with a summer coefficient of performance of 4.25) costs about one quarter to one half that of natural gas to operate.

Type of Heater	Fuel Cost	Maintenance	Total Cost
Natural Gas	\$300–\$1,100	\$50–\$100	\$350–\$1,200
Heat Pump	\$110–\$400	\$50–\$100	\$160–\$500
Solar	\$0	\$0–\$50	\$0–\$50

▲ Table 2. Typical pool-heater operating costs for a 5-m x 10-m (16-ft. x 32-ft.) pool (figures for year 2000).

Summary – The benefits of solar

These graphs summarize five good reasons for using solar energy to heat your pool.

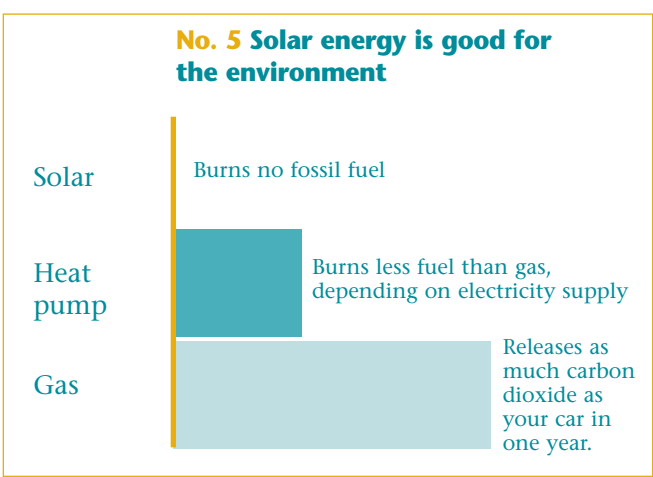
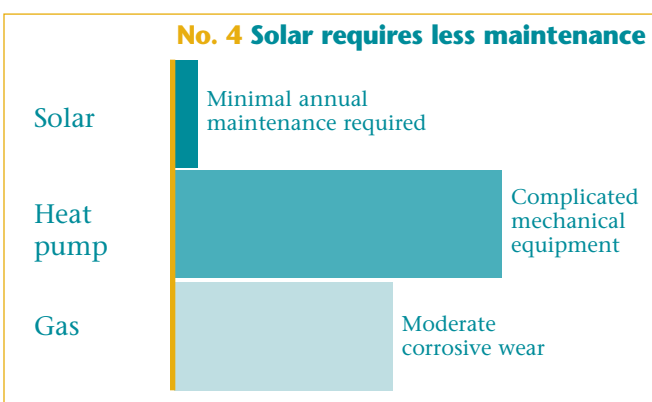
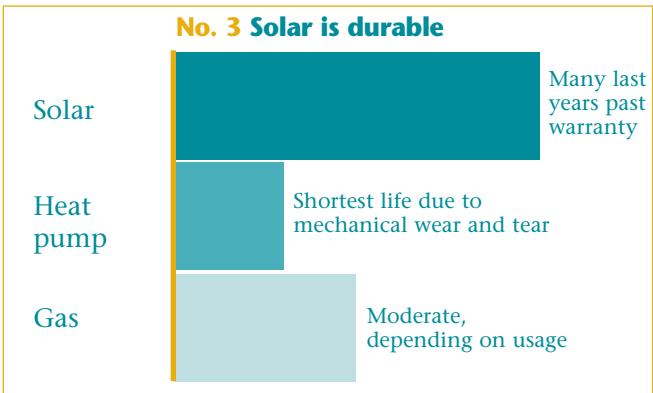
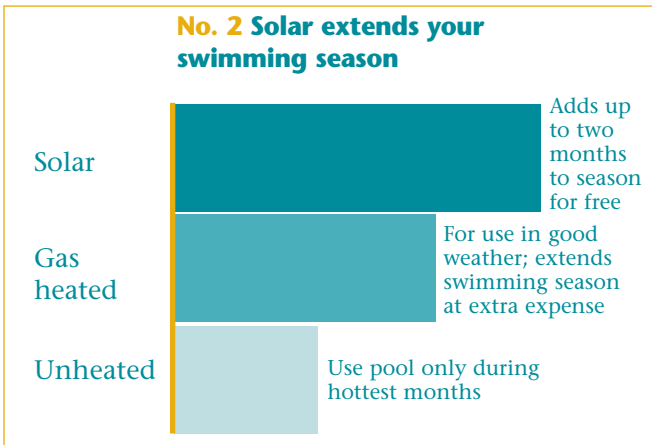
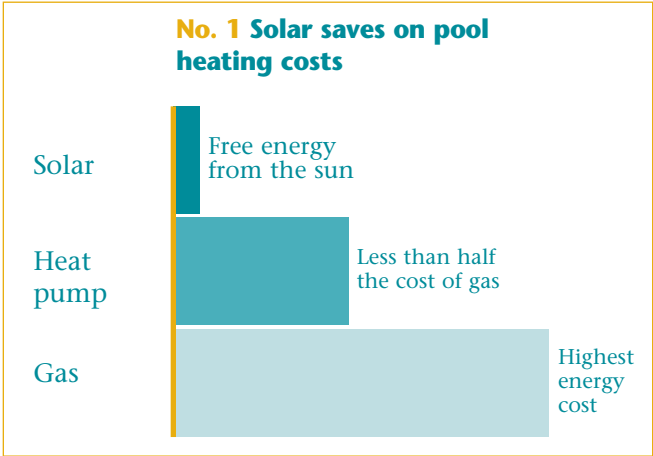

How can I best manage **my pool's energy use?**

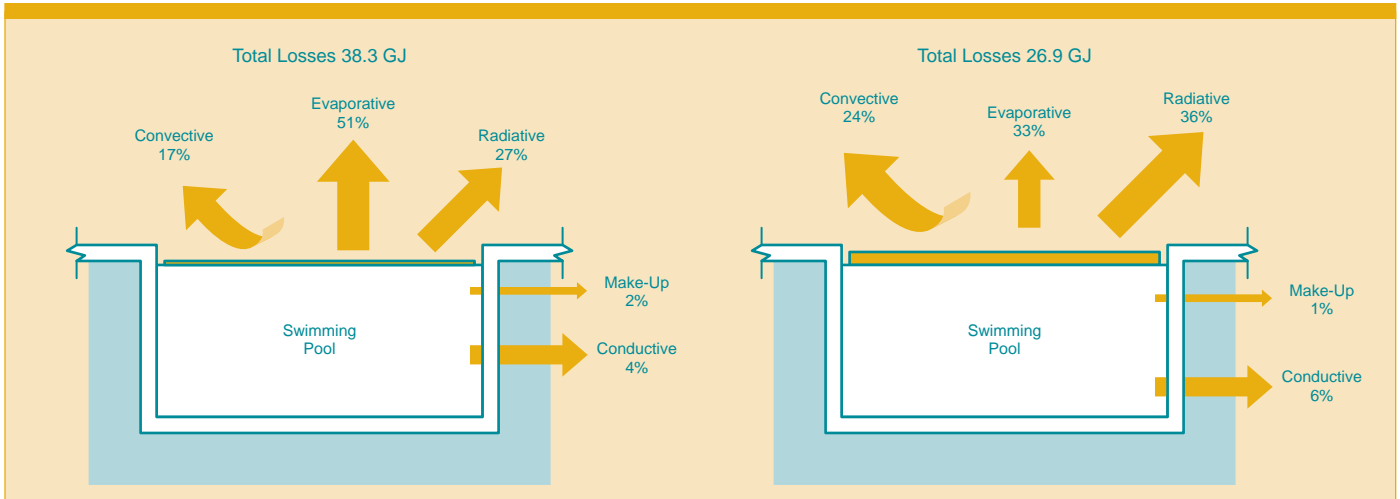

▲ Figure 3: Sample heat loss for an in-ground pool in Toronto, Ontario, in July with low cover use (left) and high cover use (right).

Pools lose heat

Since pools lose a large amount of energy, it is important to understand the different ways these losses occur. Heat loss from outdoor swimming pools occurs mainly from the surface in the form of evaporation, radiation and convection. Indoor pools lose heat primarily by evaporation. When in use, pool covers virtually eliminate losses from evaporation and also reduce losses from radiation and convection.

Evaporation

Typically, evaporation accounts for 30 to 50 percent of all heat lost from a swimming pool. In midsummer, most average-sized pools lose about 50 mm (2 inches) of water per week by evaporation, the equivalent of 150 kilowatt-hours or 500 000 BTU. These losses are higher in dry or windy weather. Evaporation also removes substantial amounts of expensive pool chemicals. Using a solar cover frequently will significantly decrease these evaporative losses, as demonstrated in Figure 3.

Radiation

Radiation transfers heat through air from warmer objects to cooler objects.

Radiation typically accounts for 25 to 35 percent of pool heat loss. Most radiative heat loss occurs on clear nights.

Convection

Convection is the transfer of heat from the pool to the air by fluid flow. When the pump is not operating, mixing warm and cool water, the warm water rises to the top of the pool. Then, through convection, the heat of the warm water escapes to the cooler air. If the wind is blowing, convective heat loss increases. As indicated in Figure 3, convection typically accounts for about 15 to 25 percent of total heat loss.

Conduction

Conduction is heat transfer by physical contact through materials. A swimming pool loses heat by conduction through the pool's walls and bottom. A high water table or flowing ground water will carry away an in-ground pool's heat through conduction.

Pools gain heat

Pools gain heat from whichever heating system you choose to install. Any swimming pool in a sunny location is also naturally heated by solar energy. Sunlight is absorbed by the water, adding heat to the pool. This “passive” solar energy is a valuable commodity to a pool owner to supplement an electric or gas heater. An unshaded swimming pool costs significantly less to heat than one that is shaded.

Solar pool covers permit some of this passive solar heating while also reducing heat losses. Many outdoor pools require no auxiliary heating during the peak of the summer (in July and August) when heat losses are low and sunshine is abundant.

How can I reduce my heating load?

To reduce your heating load, you must use energy efficiently. Energy use can be affected by pool temperature, wind exposure, pool dimensions, pump operation and pool covers.

Figure 4 illustrates typical heating costs for an average in-ground pool that is heated by natural gas.

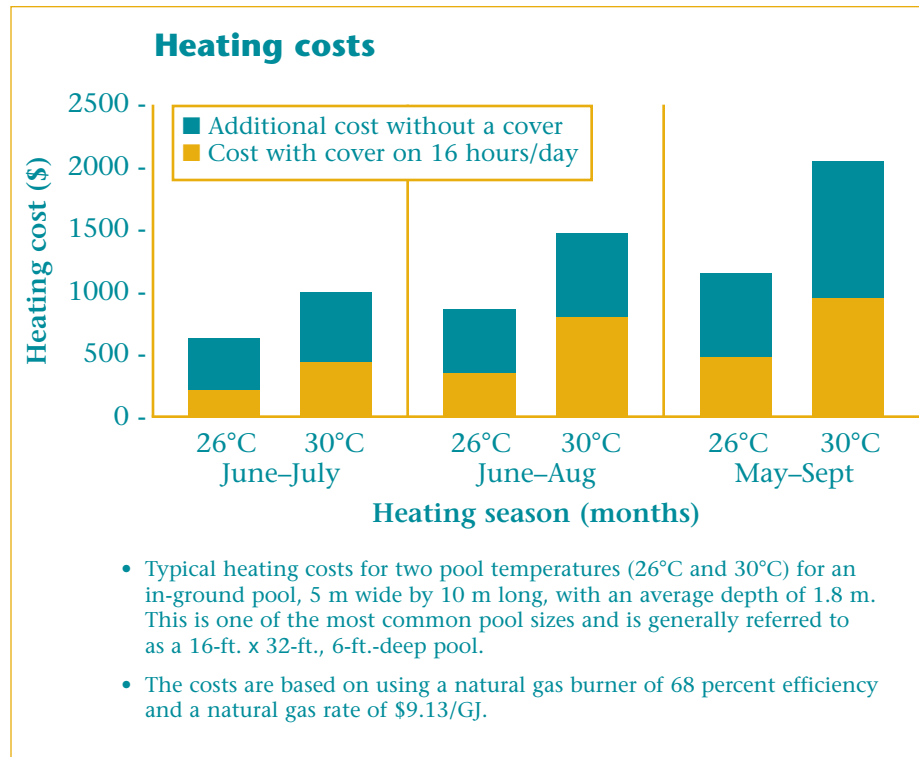

▲ Figure 4. Natural gas heating costs for an outdoor swimming pool located in Toronto, Ontario.

Monitor pool temperature

The energy consumption of an outdoor pool depends on the water temperature. For typical pool activity, temperatures can range from 26°C to 30°C. A pool heated to 30°C consumes almost twice as much energy as a pool at 26°C (see Figure 4). Allowing the pool temperature to drop when not in use will save energy and reduce operating costs.

Decrease wind exposure

The evaporative heat loss in a swimming pool is greater as wind velocity over the pool surface is increased. Generally, exposure to wind can be divided into three ranges:

- sheltered – the pool is located within a high fence;
- moderate – the pool is located close to a house or in a fenced yard; and
- open – the pool is not protected from winds.

The costs shown in Figure 4 are based on moderate wind exposure. Pools with an open exposure consume approximately 50 percent more energy. Constructing a solid fence around the pool creates a sheltered exposure, reducing energy consumption by approximately 20 percent.

Optimize pool dimensions

If you are a prospective, rather than existing, pool owner, remember that the size of pool you choose will significantly affect its energy use. Since most of a pool's heat loss occurs from the surface, the energy use of different-sized pools can be estimated by comparing surface areas. For example, a 6-m by 12-m (20-ft. by 40-ft.) pool requires approximately 55 percent more energy than the sample pool in Figure 4 as its surface is 55 percent larger.

Reduce pool pump costs

The cost of energy to heat your pool represents only a portion of your pool's operating costs. You must also factor in the cost of electricity to run your pool pump. Most pools are equipped with a pump of at least 750 watts (approximately 1 horsepower) running 24 hours a day, circulating water through a filter unit and a pool heater.

Based on this pump size, the electrical cost for operating 24 hours a day is about \$48 per month. You can use a timer on your pool

pump to reduce its hours of operation. An operating cycle of 12 hours a day is recommended and results in a saving of \$24 a month.

Use a swimming pool cover

Using a pool cover will save you energy and maintain your pool's temperature when it is not in use. If used frequently, a cover can reduce your pool's energy consumption by up to 50 percent.

Using a floating plastic swimming pool cover can significantly decrease the amount of energy required for pool heating as well as significantly reduce the loss of water due to evaporation.

Two cover types are available. The first is a solar blanket (see Figure 5), which consists of a translucent cell or bubble arrangement of 0.3 mm (12 mil) polyethylene. It allows solar radiation to warm the water. This cover primarily prevents evaporative heat loss but also reduces heat loss through convection and conduction. With careful handling to prevent bubble breakage, it can last two to three swimming seasons.

The second type, a thermal blanket (see Figure 6), consists of a 3 mm (1/8 inch) layer of closed-cell polyethylene foam covered by a protective layer of woven polyethylene.

It provides more insulation than a solar blanket, but because it is opaque it prevents solar radiation from warming the water. Leaving the pool uncovered on hot days will help warm the water. If you have a heated pool in a shaded area, an opaque blanket is the most cost-efficient cover you can get. It can last from four to five years.

SAFETY CAUTION

For safety reasons, a cover must be completely removed from the pool before anyone goes swimming to make sure no one can be trapped beneath it.

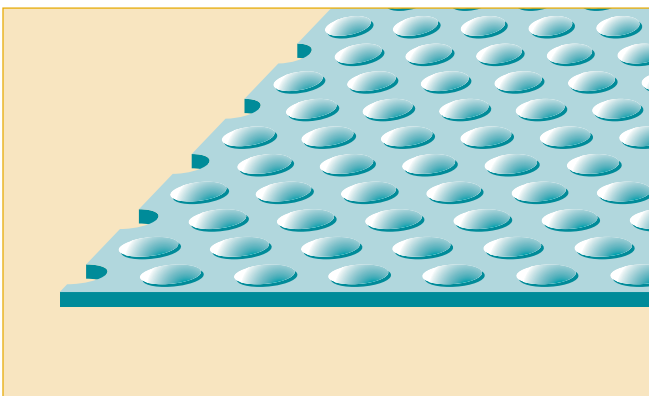

▲ Figure 5. Solar blanket.

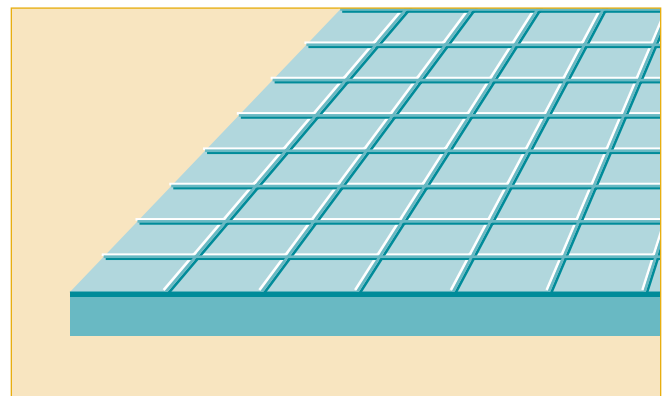

▲ Figure 6. Thermal blanket.

The effectiveness of any cover depends on the amount of time it is on the pool. The more you use your cover, the more energy you will save. For example, a cover used 14 hours a day can save energy consumption by 50 percent or more.

COVERS FOR INDOOR POOLS

Pool covers are also suitable for indoor pools. Indoor pools lose most of their heat by evaporation, and a well-fitting pool cover can virtually eliminate evaporative heat loss. As excess humidity caused by evaporation must be removed either by ventilation or refrigeration, a pool cover can have the additional benefit of saving on the cost of humidity control.

HANDLING POOL COVERS

Most people don't use their pool covers as often as they should because they are bothersome and awkward. But, the more often they are used, the more effective they are. Once removed, covers should be carried to a storage location some place out of the sun. Covers for non-rectangular pools may be cut into several sections for easier handling.

The best and easiest way to store a pool cover is on a roller at one end of the pool. Not only do rollers prevent damage to covers that can be caused by constant handling, they can usually be operated by one person.



▲ *Fonthill, Ontario.*
This 6.1-m x 12.2-m (20-ft. x 40-ft.) pool has a solar cover and eight 4.4-m² (4-ft. x 12-ft.) solar collectors.
Photo courtesy of Daystar Energy.

POOL COVER AND POOL MAINTENANCE

Pool covers and pools need maintenance. All covers require an annual cleaning with mild soap and water. In the winter, summer covers should be stored dry, rolled or folded and kept from freezing so that the plastic doesn't crack. Consult the manufacturer of your pool cover for maintenance recommendations.

No matter how you heat your pool, the more efficiently your heater works, the lower your fuel bills will be. Fuel heaters should be cleaned and adjusted annually by a technician. Clean or back-wash sand filters regularly to reduce the work your pump must do.

Summary

Here are some energy-saving tips:

- Allow the pool temperature to drop when it is not in use.
- Put a fence around your pool that can act as a windbreak.
- Prospective pool buyers – the size of your pool is a major factor in the heat energy required to keep it warm. The larger your pool, the larger the surface area from which it loses heat. Your pool's construction and location are also important.
- Maintain fuel heaters for optimum efficiency.
- When your pool is not in use, cover it to reduce evaporation and heat loss. Pool covers can save up to 50 percent of energy consumption.
- During sunny summer days, leave your solar cover on to minimize heat loss.
- If you use an opaque cover, remove it to take advantage of solar gain.



- ▲ *This solar heating system was installed in 1998 on a 5-m x 10-m (16-ft. x 32-ft.) in-ground pool with six 4.4-m² (4-ft. x 12-ft.) west-facing collectors, a solar blanket and a propane back-up heater. The owner comments, "I only really wanted 83°F [28°C] but I could sure get more than that. It went up to 94°F [34°C] before I turned it down! It doubled our season!"
Pool owner: R. Desparois, Repentigny, Quebec.
Photo courtesy of Heliocol Canada.*
-

How does solar work with **different pool types?**

Swimming pools come in various sizes, shapes and types of construction. All types of pools can benefit from solar heating.

The size of your pool is a major factor in the heat energy required to keep it warm. The larger your pool, the larger the surface area from which it loses heat. Your pool's construction and location are also important.

Outdoor pools

Above-ground

Above-ground pools are usually made using prefabricated rigid free-standing walls with vinyl liners. They are installed on the ground after the surface has been suitably levelled.

Because they are typically smaller than in-ground pools, above-ground pools may be able to experience a significant heat gain from a modestly sized solar heater.

In-ground

In-ground pools, either concrete or vinyl-lined, tend to warm up more slowly in the spring, remain somewhat cooler during the summer, and retain heat longer in the fall. They lose only a small portion of their heat through their walls and bottom to the ground.

Their pumping systems are generally more robust than above-ground pools. Solar heating, together with a pool cover, can greatly extend the swimming season for in-ground pools.



▲ A solar heating system was installed in 1997 on this 7.3-m (24-ft.) round above-ground pool. It uses five south-facing 4.4-m² (4-ft. x 12-ft.) collectors. "Solar is the best investment I've ever made," says the owner. Pool owner: Mr. Bayard, Montréal Quebec. Photo courtesy of Heliocol Canada.

Indoor pools

Indoor pools are usually constructed of concrete and are part of the basic design and structure of the building they are in. Since they are less affected by outdoor weather conditions, they are particularly suited to solar heating.

Unless an indoor pool is located so that sunshine falls on its surface for direct heat gain, it will require heating year-round. Solar heating systems for indoor pools should be designed by a solar professional. A pool cover should be used to reduce evaporation and subsequent humidity problems.

Enclosed pools

Unlike an indoor pool, an enclosed pool is not intended for year-round use, and the enclosure is not heated. But it can extend the length of the swimming season considerably. Even though heat loss is reduced by the enclosure, an insulated pool cover is still advisable.

Pools can be enclosed within an addition to a home, a separate structure or an air-supported clear plastic tent. While all such pools will benefit from direct sunlight, one that is enclosed in an air-supported plastic tent with good southern exposure will receive the most light and heat.

Hot tubs and spas

Solar collectors can also be used for heating hot tubs and spas. Although the water temperature required is hotter than for swimming pools, typically 40°C (104°F), the volume and exposed surface area are smaller and therefore a smaller collector area is required. Glazed solar collectors are generally required since they heat to higher temperatures. Unglazed collectors can be considered when a hot tub is allowed to drop to ambient temperature when not in use.

The high water temperature creates a large energy requirement, especially when a tub has been refilled with cold water. For example, a 1.5-m (5-ft.) diameter hot tub holds 2250 litres (500 gallons) and requires 87 kilowatt-hours of electricity during start-up, or about \$6.55 if your rate is 7.5 cents per kilowatt-hour. Turbulence and air blowers add considerably to the rate of heat loss. They should be turned off when the tub is not in use.

Pool Profile

Name of owner: Greg Henderson, Campbellville, Ontario

Pool size and type: 4.2-m x 8.4-m (14-ft. x 28-ft.) indoor pool

Year of solar installation: 1998

Solar collector array: Seven 4.4-m² (4-ft. x 12-ft.) solar collectors and propane heater for wintertime

Owner's comments:

"When we moved into our new home we didn't realize how much it would cost to heat the pool. We were paying \$200 to \$300 per month for propane and that cost would be 50 percent higher today.

"Our solar heater now does all the heating from April to November, keeping the pool above 80°F [27°C]. The system paid for itself in two years! The only maintenance involved is draining the system and starting it up in the spring, which takes me a total of about half an hour per year. I also think it's good for the environment if I can avoid burning propane whenever possible.

"I would recommend solar for outdoor as well as indoor pools."

What types of **solar collectors** are there?

Unglazed solar collectors – The common collector for solar pool heating

There are different types of “unglazed” solar collectors specially designed for swimming pools. Most of the collectors in use today are made of either rubber or ultraviolet (UV) stabilized plastic. Collectors typically consist of many 6-mm (1/4-in.) tubes running the length of the collector feeding into 38-mm (1-1/2-in.) or 51-mm (2-in.) diameter top and bottom header pipes. The header pipes are connected to the adjacent collectors to carry the main flow of water.

Plastic collectors are semi-rigid and become more pliable when heated. Most have the riser tubes welded adjacent to each other to form one solid surface. Others have the tubes separated by an air gap that allows air to pass between. This gap increases the heat loss from the panel, but makes it more stable and less prone to uplift during high winds. Plastic collectors are 1.2-m (4-ft.) wide and come in three standard lengths: 2.4-m (8-ft.), 3.0-m (10-ft.) or 3.7-m (12-ft.). They are connected together with rubber couplings and stainless steel clamps and typically last 15 to 20 years in the Canadian climate.

The other material used for unglazed collectors is rubber. These collectors come in flexible strips that are assembled onto rigid header pipes during installation. The strip form of the rubber allows the collector to be built to any practical length. These collectors tend to have lower efficiencies since there is a space between riser tubes and because the tubes transfer heat slower due to their thicker walls. Header pipes usually come in 0.3-m (1-ft.) sections that are connected using an O-ring seal, lubricant and a grasping clip. These collectors have a field life of up to 15 years.

Efficiency and rating of solar collectors

Each brand of solar collector has been tested to determine its solar energy collection efficiency, or thermal performance rating. Testing takes place at Canada's National Solar Test Facility and at the Florida Solar Energy Center (FSEC) in the United States. The Canadian Solar Industries Association (CanSIA) publishes test results in their *Directory of Approved Products* for collectors tested in Canada.

Solar energy collection efficiency ratings work in the following way: an efficiency of 80 percent means the collector is able to absorb 80 percent of the energy in the sunlight striking its surface and transfer it into the heated pool water. Collector performance is usually stated as BTU per square foot per day (BTU/sq. ft./d) according to the Florida Solar Energy Centre (FSEC) standard test. Some collectors may be rated as high as 1000 BTU/sq. ft./d and others as low as 700 BTU/sq. ft./d.

When purchasing a solar heater, it is important to consider the collector efficiency. A smaller area of higher-performing collectors will provide the same heating power as a larger area of lower-performing collectors. A system using panels with higher performance will maintain a higher pool temperature over the summer.

Accordingly, expect the price of a lower-efficiency collector to be proportionally less than the price of a higher-efficiency collector.

Factors affecting collector efficiency

Air Temperature

Solar collectors perform better with warmer air temperature. As the air cools, the collector loses more heat to the air and transfers less heat to the pool water.

Flow Rate

Many manufacturers recommend a flow of 10 to 15 litres (approximately 3 to 4 U.S. gallons) per minute per solar collector, which most pool pumps can easily accommodate. Slower flow rates will slightly reduce the collector's efficiency.

Wind on Collector

The convective heat loss from the collector to the air around it increases with increased exposure to wind.

Shading on Collector

Collectors shaded from the sun by trees or buildings will generally not add useful heat to the pool water unless the air temperature is higher than the pool temperature.

Pool Profile

Name of owner: Danny Ethier, St. Catharines, Ontario

Pool size and type: 5.5-m x 11-m (18-ft. x 36-ft.) in-ground, outdoor pool

Year of solar installation: 1986

Size of collector array: Six 3-m² (4-ft. x 8-ft.) solar collectors

Owner's comments:

"What I really like about the solar system is the efficiency and cost savings. My friends are installing solar on their pools since the monthly gas bill is unnecessary when solar performs so well.

"I open my pool the end of April and swim to the second week of October. When I open my pool in April, with just three or four days of good weather I can get my pool from 60°F to 78°F [16°C to 26°C]. I really get two more months of swimming than most pool owners [that do not have a heater]. And I like to keep the temperature at 88°F to 90°F [31°C to 32°C], which is comfortable for my kids and the neighbours' kids. I use the pool cover at night to keep the heat in.

"I installed solar originally with two other neighbours. My mother and two more neighbours have solar now as well. Another friend was offered a gas heater for free but he bought solar instead. Even my pool dealer switched from a gas heater to a heat pump to solar.

"I've been pushing solar heating to any pool owners I know, and I welcome anyone to come and visit my pool for a tour of how it works."

Solar collector kit for above-ground pools

Some dealers carry specialty kits for above-ground pools. These typically include a 1.2-m by 6.1-m (4-ft. by 20-ft.) unglazed solar collector and the valves and tubing to connect to your pool filter system. One collector will heat a 14-ft. round pool. The collector is usually placed on the lawn or propped up against the wall of the pool, facing south.

This kit is relatively inexpensive (around \$300) and easily installed by the homeowner. Although they tend to be lower priced, they are also lower quality. They usually have much less ultraviolet inhibitor and less warranty coverage. Most are only covered for 100 percent of their value for one year. They have a field life of up to 10 years. Make sure the collector area is sufficient for the size of your pool, as explained in the section on determining the right size for your solar heater on page 19.

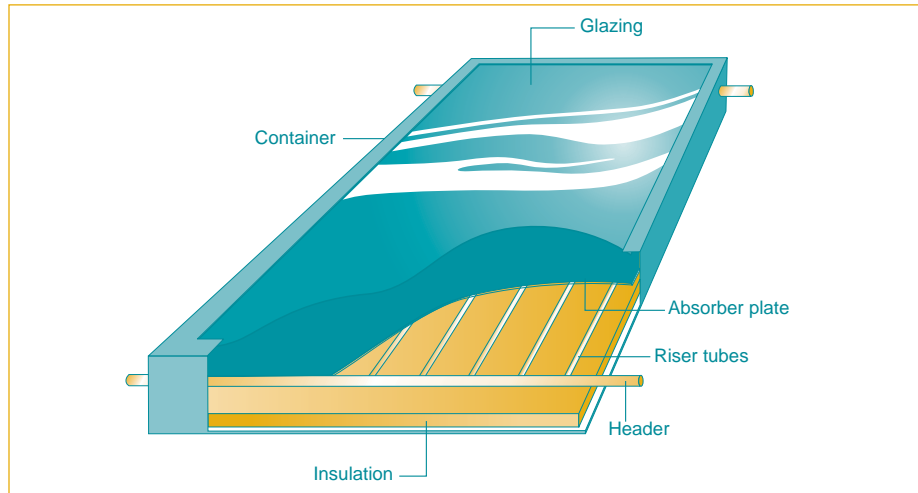

▲ Figure 7. Schematic of a glazed collector.

Glazed solar collectors

A glazed solar collector consists of copper tubes attached to a black metal absorber plate (see Figure 7). The whole collector is housed within an insulated box and covered with a sheet of glass to prevent heat loss. Glazed collectors operate at a higher temperature and are less affected by heat loss due to wind and cool air temperatures. They are more commonly used for solar domestic hot water heating because of the higher temperatures they achieve.

Although not nearly as common for pool heating as unglazed, glazed collectors can be especially useful for indoor pools that are used year-round or for outdoor pools in cool or windy climates. For year-round pool heating, a heat exchanger can be used to transfer heat to the pool water and freeze-protect the solar collectors. Since glazed collectors are more expensive (typically three times the cost of unglazed), their economics for solar pool heating are less attractive.

What size **solar heater** do I need?

Since a pool loses most of its heat from the surface, the size of a solar heater can be based on the pool's surface area.

Most pools need a solar heating system that is 50 percent to 75 percent of the pool area. For example, a 5-m by 10-m (16-ft. by 32-ft.) in-ground pool has an area of 50-m² (512-sq. ft.). It would typically need between 25-m² (256-sq. ft.) and 37.5-m² (384-sq. ft.) of solar collectors to adequately heat it. This could be obtained by using six to eight 4.4-m² (4-ft. by 12-ft.) collectors.

If solar is the only heating source and a solar cover is routinely used, as a general rule the collector area is typically at least 50 percent of the surface area of the pool.

In some cases, pool owners may choose to install a smaller solar area. If they want a shorter swimming season or plan to use a backup gas or electric heater, a smaller collector area will be capable of providing most of the pool heating during the peak swimming months. Those using a fuel heater will find that a complementary solar heater makes economic sense because of the savings in fuel. And, smaller systems can usually be enlarged, if required, in the future.



▲ *Ottawa, Ontario.
6.1-m x 12.2-m (20-ft. x 40-ft.) in-ground pool, eight 4.4-m² (4-ft. x 12-ft.) solar collectors.
Photo courtesy of Heliocol Canada.*

The exact area of a collector will depend on the amount of shading on the pool surface, the roof orientation and tilt, the use of a pool cover and the desired temperature. Other considerations include the wind speed on the pool surface and solar collectors, any shading on the solar collectors and the length of swimming season.

A solar heating installer will combine the following design factors with their knowledge of the regional climate and the pool owner's particular operating needs to develop an appropriately sized solar heating system.

Shading on the pool

The prime hours for solar pool heating, when the sun is strongest, are between 10 a.m. and 5 p.m. Solar gain before and after these times is much less critical. A partially or fully shaded pool receives less passive solar energy gain, and so needs more external heat added from the pool heater. Shaded pools require a larger area of solar collectors to maintain the pool temperature.

Location of solar collectors – Orientation and tilt

Ideally, solar collectors should face due south to intercept the sun's rays at the most direct angle (see Figures 8 and 9). At midday, when the sun shines most intensely, it is located due south in the sky. An orientation of up to 45° to the east or west of due south will not affect performance dramatically. Collectors can even be placed on either a west- or east-facing roof. However, west-facing is preferable since the higher afternoon air temperature improves the collector's performance.

The optimum tilt of the collector (the angle off horizontal) for summer heating of pools is between 15° to 40° for southern Canada. Normally, collectors are mounted directly on the roof since it is the least expensive option.

If the roof slope is less than 15° or greater than 40°, any reduction in heating efficiency can be accommodated by increasing the

collector area. Flat roofs generally require a support rack of at least 10° slope to ensure that the collectors drain properly and that roof penetrations are avoided where water can pool.

Use of a pool cover

As mentioned in the section on managing pool energy use (page 10), the absence of an insulating pool cover dramatically increases a pool's heating requirements. Pool owners who have decided to forego a pool cover must install up to 50 percent more solar collectors to make up for the extra heating need.

Pool Profile

Name of owner: Margaret Louwerse, Oakville, Ontario

Pool size and type: 4.5-m x 9.0-m (15-ft. x 30-ft.) above-ground, outdoor pool

Year of solar installation: 1998

Solar collector array: Five 4.4-m² (4-ft. x 12-ft.) solar collectors

Owner's comments:

"We built our pool in 1997 and found the temperature just a little too cool for our young kids, even using a solar cover.

"We had solar installed and we couldn't believe the temperature shot up to 99°F [37°C] on the first weekend. We keep our pool at 86°F [30°C] and swim from the beginning of May to late September, and the kids can play in it all day now. Even with the cool weather this summer, our pool was still comfortable.

"Solar was the best investment we made that year – I never considered using natural gas because of the energy and environmental consideration. Service was reliable and helpful."

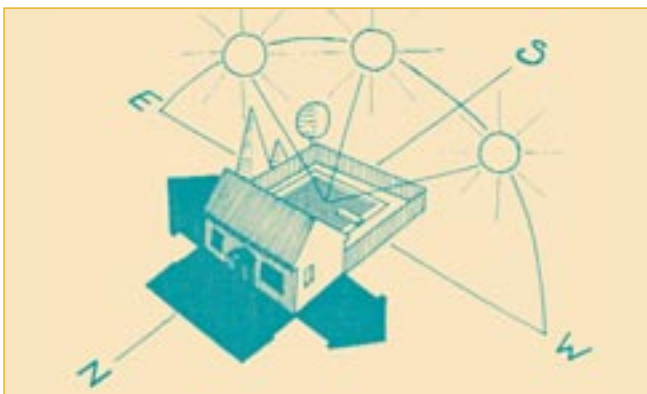

▲ Figure 8. Diagram of the sun's path.

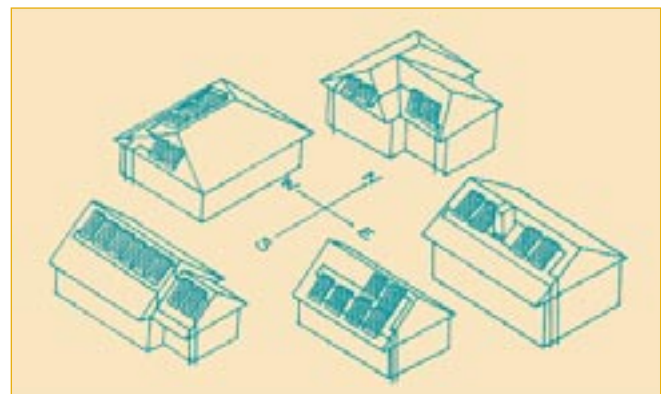

▲ Figure 9. Typical orientations for solar collectors.

How will my solar heater **be installed and maintained?**

Most collectors can be mounted on your roof

In most cases, solar collectors are installed on the south-facing roof of a house, garage or shed. They have a low profile and clean design allowing them to blend in with most traditional roofing materials. Unglazed solar collectors are lightweight, adding about 0.07 kilopascals (kPa) – 1-1/2 pounds per square foot (psf) – to the roof, which is negligible compared to snow load, which can be 5 to 7 kPa (approximately 100 to 150 psf).

Fasteners

Collectors should be fastened to the roof with a high-quality fastener. Some systems use a two-part cleat, which is lag bolted into the sub-roof and sealed using industrial-grade caulking. UV-resistant synthetic webbing strap is laid across the body of collectors and held down with the cleat. Other brands fasten an aluminum bar to the roof, which is the mounting point for the collectors.

Modern mounting systems are very reliable and completely seal the roof against leaking. Roof penetrations, however, should only be made on sloping roofs. Some manufacturers have wind-tunnel tested their mounting systems up to speeds of 180 km/hr. Ask your installer for details.

Flat roofs generally require a sloped rack to ensure that:

- a) water in the solar collectors drains properly, and

- b) roof penetrations are avoided where water can pool.

The rack can be weighted down or secured with a cable to ensure it is stable in winds.

Thermal expansion

Hot plastic collectors may expand as much as 2.5 cm over a 3-m length (1 in. over 10 ft.). They must be carefully mounted to prevent damage from expansion and contraction.

The surface beneath the panels must be smooth to prevent damage to the panels from sharp projections in the roof and to avoid damage from rubbing when the panels contract and expand. Manufacturers have recommendations on how to fasten the panels to the roof and prevent damage by wind, snow and ice.

Piping installation

The piping used for solar heaters is standard PVC. The pipe is naturally white but can be painted to match the colour of your roof and exterior walls.

After the pipe is cut, the ends must be de-burred since small shavings of plastic can clog the small fluid passageways in some collectors.

The pipes should be arranged so that they can be easily drained to prevent damage to the system from freezing. On horizontal runs, the pipe should slope 1 cm for every 5 m of length. In general, the pipe runs should be short and direct.

Like the panels, plastic pipe will also expand and contract, so allowances for that must be made during installation. A 30-m (100-ft.) length of plastic pipe may expand as much as 25 cm (10-in.).

It is important that all the collectors receive an equal flow of water. The standard technique, as shown on page 6, is to connect them in parallel with the supply pipe feeding from the bottom. The water travels up the collectors and is carried back to the pool through a return pipe at the top. The return flow pipe is thus diagonally opposite to the supply pipe. For adequate flow, often a 51-mm (2-in.) pipe is used for the supply line and 38-mm (1-1/2 in.) is used for the return line.



▲ Welland, Ontario.
This 5-m x 10-m (16-ft. x 32-ft.) free-form pool is heated by six 4.4-m² (4-ft. x 12-ft.) solar collectors mounted on the garage.
Photo courtesy of Daystar Energy.

Collectors can also be mounted on racks

Ground-mounted racks are used when roof space or exposure is inadequate. They can be built from pressure-treated or rot-resistant wood or from metal bars, and can also serve as a storage shed or as a weather-protected area for the pump, filter and other pool controls. A typical rack is shown in Figure 10.

Rack support posts should extend below the frost line, usually 1.2 m (4 ft.) below ground, and be anchored in concrete. They should be positioned so that snow and ice sliding off adjacent roofs will not damage the collectors.

Before building such a system, check to see if a building permit is required.



▲ *White Rock, British Columbia.
Eight 4-m² (4-ft. x 10-ft.) solar collectors on a wooden ground rack.
Photo courtesy of Taylor Munro Energy Systems.*

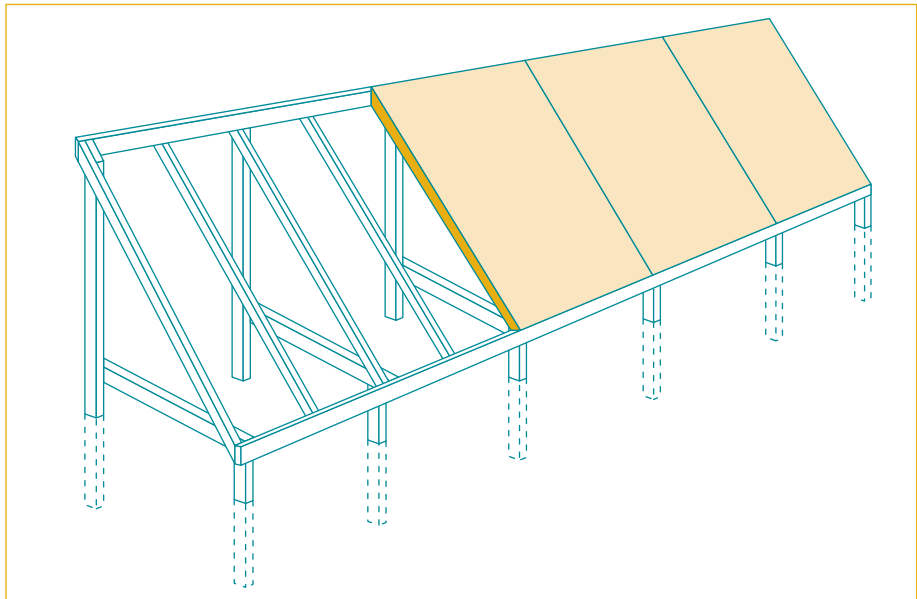

▲ *Figure 10. Ground-mounted rack.*

You can choose a manual or automatic control valve

Solar heating systems can be operated either manually or automatically. A manual control valve (see Figure 11) is a simple three-way valve that is turned by hand to divert water to the collectors during sunny weather. A good automatic controller, though more expensive, can improve your system's performance by up to 30 percent. Using temperature sensors, the controller diverts pool water to the collectors only when sufficient solar energy is available.

Figure 12 shows a typical automatic controller. An automatic controller should allow manual override and have a light that shows you when it is on and when the collectors are circulating. And, since you might want the pool cooler in midsummer than earlier or later in the season, it should also allow you to change the desired pool temperature setting.

If your pool becomes too warm, circulating through the collectors at night will cool the water. Some automatic controllers include this option.

Activating the system is straightforward

Once the system is installed, the collectors and piping should be inspected for leaks. The supply and return lines should show a

temperature rise of about 5°C (9°F) during steady flow on a sunny day.

A good solar pool heating system must also include the following:

- a vacuum-breaker air vent at high points in the piping system for draining;
- isolation ball valves on the feed and return lines;
- drain taps on the feed and return pipes at the low points in the piping system; and
- a swing-type check valve to prevent water from flowing backward through the filter when the collectors drain.

Maintenance is easy

A solar heating system should operate problem-free. Only the controller has electrical and moving parts. Controllers and sensors should last at least 10 years, if not the lifetime of the collectors.

Due to breakdown by ultraviolet (UV) radiation, the plastic collectors will degrade slowly and eventually produce leaks. It is beneficial after 10 years to turn the collectors over, exposing the shaded side. This can add years to the life of the system. As well, some collectors are designed for simple repair using special rubber plugs.

Special care must be taken with winterization

In the fall, prior to a serious risk of freezing weather, the solar



▲ Figure 11. Manual three-way diverter valve.
Courtesy of Pentair Pool Products

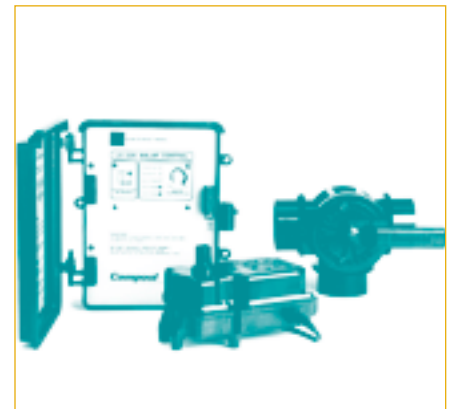

▲ Figure 12. Automatic controller.
Courtesy of Pentair Pool Products

collectors must be completely drained. Most of the water can be drained into the pool by turning off the pump. Any water remaining in the pipes should be drained through taps located on the low points of the feed and return pipes. Buried pipes will need irrigation boxes and drain valves. Alternately, the entire system can be blown out with a wet/dry vacuum.

How do I make the **best decision as a consumer?**

A solar pool heating system is a major investment. Having your system installed by a solar specialist protects your investment and assures that the system will perform as predicted. The contractor should provide a one-year warranty for the labour, which covers leaks and damage to the roof.

Most solar contractors will offer a winter shutdown and spring start-up service, which includes a complete system checkup.

Selecting a solar contractor

Solar companies are generally listed in the yellow pages under “Solar Energy” or “Solar Energy Equipment and Systems.” If there is no local contractor in your area, contact the Canadian Solar Industries Association (CanSIA) at (613) 736-9077. Or visit its Web site at www.cansia.ca, which includes a directory of Canadian solar energy companies. In the province of Quebec, contact Énergie solaire Québec at (514) 392-0095. Many contractors are willing to travel outside their home territory (within reason) to service customers.

For help on selecting a contractor or dealer, complete the consumer checklist on page 26.

Selecting a solar collector

When choosing a solar collector, consider the efficiency, durability and cost of the product. Ask the contractor for references if you would like confirmation on the quality of the product. A good quality collector should last 15 years or longer.

If you are interested in the collector efficiency rating, consult the *CanSIA Directory of Approved Products*.

Understanding the collector’s warranty

Most solar collectors sold in Canada have a 10- to 15-year warranty. Some warranties will include repair or replacement of faulty collectors during the entire warranty period. Others are limited warranties, pro-rated in value after a number of years. Most warranties do not cover labour or shipping costs.

For the warranty to take effect, the collectors must be installed, or the installation approved, by a qualified contractor. Freeze damage to the collectors is not covered by most warranties since the collectors must be drained at the end of the swimming season.

Determining your potential costs

Heat Pump		Natural Gas Heater		Propane Heater		Solar Heater	
Parts	\$ _____	Parts	\$ _____	Parts	\$ _____	Parts	\$ _____
Labour	\$ _____	Labour	\$ _____	Labour	\$ _____	Labour	\$ _____
Additional installation costs		Additional installation costs		Additional installation costs		Additional installation costs	
Example: Electrical line installation (if separate)	\$ _____	Example: Natural gas line installation (if separate)	\$ _____	Example: Propane tank installation (if required)	\$ _____		
Others:	\$ _____	Others:	\$ _____	Propane line installation (if separate)	\$ _____		
	\$ _____		\$ _____	Others:	\$ _____		\$0.00
Permit	\$ _____	Permit	\$ _____	Permit	\$ _____	Permit	\$ _____
Total installation costs	\$ _____	Total installation costs	\$ _____	Total installation costs	\$ _____	Total installation costs	\$ _____
Estimated electricity costs over 15 years (multiply estimated annual electricity costs* by 15)**	\$ _____	Estimated natural gas costs over 15 years (multiply estimated annual natural gas costs* by 15)**	\$ _____	Estimated propane costs over 15 years (multiply estimated annual propane costs* by 15)**	\$ _____	Estimated fuel costs over 15 years	\$0.00
Total heat pump costs after 15 years	\$ _____	Total natural gas heater costs after 15 years	\$ _____	Total propane heater costs after 15 years	\$ _____	Total solar heater costs after 15 years	\$ _____

*If you have an existing pool heater, refer to your monthly fuel bills. If you are purchasing a heating system, ask your pool dealer what you could expect to pay for electricity or fuel over the course of a year.

**Please note that this calculation does not take into account electricity or fuel price increases.

Consumer checklist

To make an informed decision when purchasing a solar pool heater, there are questions you should ask and issues you should be aware of. Use this checklist to help you make an informed decision when selecting your heater and solar contractor.

Selecting a solar contractor

Is the solar contractor listed with the Canadian Solar Industries Association?	Yes <input type="checkbox"/>	No <input type="checkbox"/>
Can the contractor provide at least three references of systems that he/she has installed?	Yes <input type="checkbox"/>	No <input type="checkbox"/>
Can you make a site visit to any of the contractor's previous installations?	Yes <input type="checkbox"/>	No <input type="checkbox"/>
Has the contractor clearly outlined the type of servicing and maintenance contract services he or she will provide?	Yes <input type="checkbox"/>	No <input type="checkbox"/>
Has the contractor clearly outlined the terms of the contract you will be signing?	Yes <input type="checkbox"/>	No <input type="checkbox"/>
Are building permits required? Are plumbing and electrical inspections required? If so, who is responsible for arranging these?	Yes <input type="checkbox"/>	No <input type="checkbox"/>
Will the contractor be responsible for winterizing the system?	Yes <input type="checkbox"/>	No <input type="checkbox"/>
Will you?	Yes <input type="checkbox"/>	No <input type="checkbox"/>
Will the contractor provide maintenance or operational instructions?	Yes <input type="checkbox"/>	No <input type="checkbox"/>

Selecting a solar collector

Can the contractor provide references for the solar collector sold to you?	Yes <input type="checkbox"/>	No <input type="checkbox"/>
What is the collector's performance rating from the <i>CanSIA Directory of Approved Products</i> or the Florida Solar Energy Center?	_____	
What is the collector's anticipated life span?	_____	
How much does the collector cost?	\$ _____	

Understanding the solar collector's warranty

What is the length of the collector's warranty?	_____	
Does the warranty include repair or replacement of faulty collectors during the entire warranty period?	Yes <input type="checkbox"/>	No <input type="checkbox"/>
Does the warranty cover labour or shipping costs?	Yes <input type="checkbox"/>	No <input type="checkbox"/>
Will the installation be completed or approved by a qualified contractor?	Yes <input type="checkbox"/>	No <input type="checkbox"/>

Appendix 1: Other applications for solar water heating

Solar energy can be used to heat water for a variety of uses. In addition to pool heating, a solar domestic hot water system can be practical and cost-effective.

Any business or public facility that uses a large quantity of hot water may also benefit from solar water heating. Some examples of commercial applications in Canada include the following:

- public swimming pools;
- car washes the following;
- fish hatcheries;
- agricultural and food processing; and
- parks and campgrounds.

Related publications

Solar domestic hot water systems are reviewed in *Solar Water Heating Systems: A Buyer's Guide*. To order a copy of this or other publications on renewable energy, please call NRCan's toll-free line at 1 800 387-2000. You can also download a copy from our Web site at <http://www.nrcan.gc.ca/redi>

Further information

To learn more about solar water heating, contact the following:

Renewable and Electrical
Energy Division
Energy Resources Branch
Natural Resources Canada
580 Booth Street, 17th Floor
Ottawa ON K1A 0E4
Fax: (613) 995-0087
Web site:
<http://www.nrcan.gc.ca/redi>

or

CANMET
Energy Technology Branch
Natural Resources Canada
580 Booth Street, 13th Floor
Ottawa ON K1A 0E4
Fax: (613) 996-9418
Web site:
<http://www.nrcan.gc.ca/es/etb>

Canadian Solar
Industries Association
2415 Holly Lane, Suite 250
Ottawa ON K1V 7P2
Tel: (613) 736-9077
Fax: (613) 736-8938
Web site: <http://www.cansia.ca>

Énergie solaire Québec
460, Sainte-Catherine Street West,
Suite 701
Montréal QC H3B 1A7
Tel.: (514) 392-0095
Fax: (514) 392-0952
Web site: <http://www.esq.qc.ca>

To read more on solar water heating technologies or other types of renewable energy technologies, visit the Web site of NRCan's Canadian Renewable Energy Network (CanREN) at <http://www.canren.gc.ca>.

Appendix 2: Glossary

British Thermal Unit (BTU)

A unit of energy used to measure natural gas. One thousand BTUs equals approximately one megajoule and 1 million equals approximately one gigajoule.

Coefficient of performance (COP)

The rating system used for heat pumps. It is the ratio of heat output to electricity input. A typical rating falls between 3 and 5.

Fossil fuel

A hydrocarbon fuel extracted from the earth's crust, including natural gas and oil. Fuels derived from natural gas and oil include propane and gasoline.

Gigajoule (GJ)

A unit of energy commonly used to measure natural gas. Equals 278 kilowatt-hours or approximately 1 million BTUs.

Glazed solar collector

A glass-covered metal solar collector that operates at higher temperatures than unglazed collectors.

Greenhouse gas

Gases such as carbon dioxide (CO₂) that absorb and trap heat in the atmosphere. The increased production of these gases from human activity is linked to accelerated warming of our atmosphere, known as climate change.

Heat pump

An electric heater that extracts heat available in the air to heat pool water.

Kilopascals (kPa)

A unit of pressure. Equals approximately 21 pounds per square foot.

Megajoule (MJ)

A unit of energy. Equals approximately 1000 BTUs.

Passive solar heating

Sunlight absorbed into the pool water causes natural heating.

Payback period

The time it takes your savings in avoided fuel costs to equal the capital cost investment of your solar heater, or how fast your system pays for itself in fuel savings. For example, a \$4,500 solar heater that saves \$1,500 per year in fuel has a payback period of three years. If your pool has no heater or if you are replacing your conventional heater, the cost of the new heater must be included in the payback period.

Performance rating

The effectiveness of the solar collector at converting the sun's energy into heat. Expressed as megajoules per square metre per day (MJ/m²/d) or BTU per square foot per day (BTU/sq. ft./d).

Solar blanket

A floating polyethylene material that insulates the pool surface and allows light to pass through into the pool.

Solar collector

A device that absorbs solar energy and converts it into usable heat.

Thermal blanket

A floating foam cover that insulates well but does not allow light to pass through it into the pool.

Unglazed solar collector

A plastic or rubber solar collector that operates at pool temperatures.

Reader Survey

Thank you for your interest in Natural Resources Canada's (NRCan) *Residential Solar Pool Heating Systems: A Buyer's Guide*. To improve this Guide, we would like to ask you to take a few moments to answer some questions.

Where did you receive your copy of the *Buyer's Guide*?

Introductory brochure (NRCan) Solar dealer Pool retail store CanSIA
Trade show Other

Did you find this publication informative? Yes No

How much did you know about solar pool heating systems before reading the *Buyer's Guide*?

Everything A lot A little Nothing

Please rate the publication on the following characteristics:

	Excellent	Good	Average	Satisfactory	Poor
Easy to understand	<input type="checkbox"/>	<input type="checkbox"/>	<input type="checkbox"/>	<input type="checkbox"/>	<input type="checkbox"/>
Length	<input type="checkbox"/>	<input type="checkbox"/>	<input type="checkbox"/>	<input type="checkbox"/>	<input type="checkbox"/>
Clarity	<input type="checkbox"/>	<input type="checkbox"/>	<input type="checkbox"/>	<input type="checkbox"/>	<input type="checkbox"/>
Completeness	<input type="checkbox"/>	<input type="checkbox"/>	<input type="checkbox"/>	<input type="checkbox"/>	<input type="checkbox"/>
Photographs	<input type="checkbox"/>	<input type="checkbox"/>	<input type="checkbox"/>	<input type="checkbox"/>	<input type="checkbox"/>
Graphics	<input type="checkbox"/>	<input type="checkbox"/>	<input type="checkbox"/>	<input type="checkbox"/>	<input type="checkbox"/>
Format/organization	<input type="checkbox"/>	<input type="checkbox"/>	<input type="checkbox"/>	<input type="checkbox"/>	<input type="checkbox"/>

Please feel free to add any comments or suggestions.

If I install a system, it would be for: A house An apartment building Other (specify):

I would like to receive a list of solar pool dealers or installers in my area. Yes No

Please provide your name and address (please print).

Name:

Street:

City:

Province:

Postal code:

Telephone:

E-mail:

Please send the completed form to
Natural Resources Canada
Renewable and Electrical Energy Division
580 Booth Street, 17th Floor
Ottawa ON K1A 0E4
Fax: (613) 995-0087

